

A	B	Slats
18" (457.2)	9.49	12.44
20" (508.0)	11.49	12.44
22" (558.8)	13.49	14.44
24" (609.6)	15.49	16.44
26" (660.4)	17.49	18.44
28" (711.2)	19.49	20.44
30" (762.0)	21.49	22.44
32" (812.8)	23.49	24.44
34" (863.6)	25.49	26.44
36" (914.4)	27.49	28.44

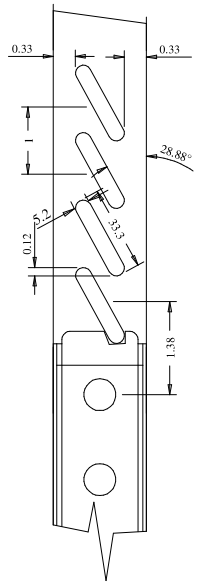

Titulo: RZ#801 - 84" x 18" a 36" x 35mm - Primed					
	Client	963- Square One			
	Designer	Luiz Antônio	Approval	Charles	Reviewed by Luiz Antônio
	Date	20-02-2023	Date	20-02-2023	Review Date 20-02-2023

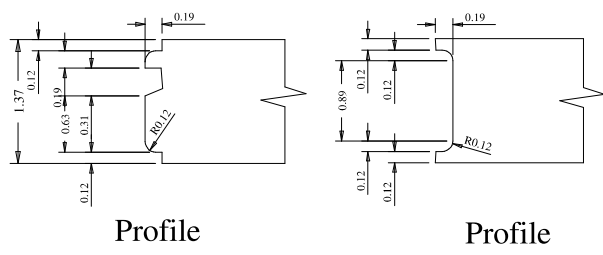
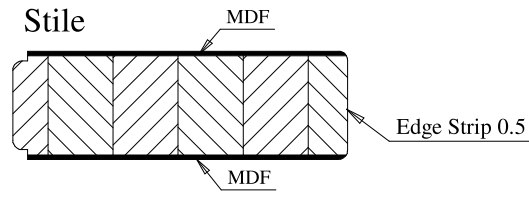
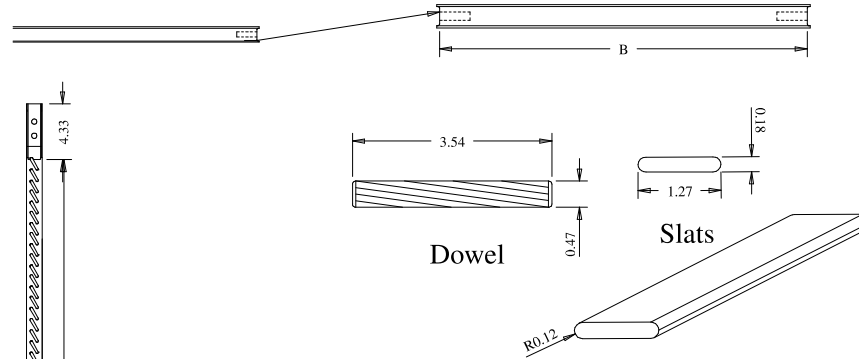
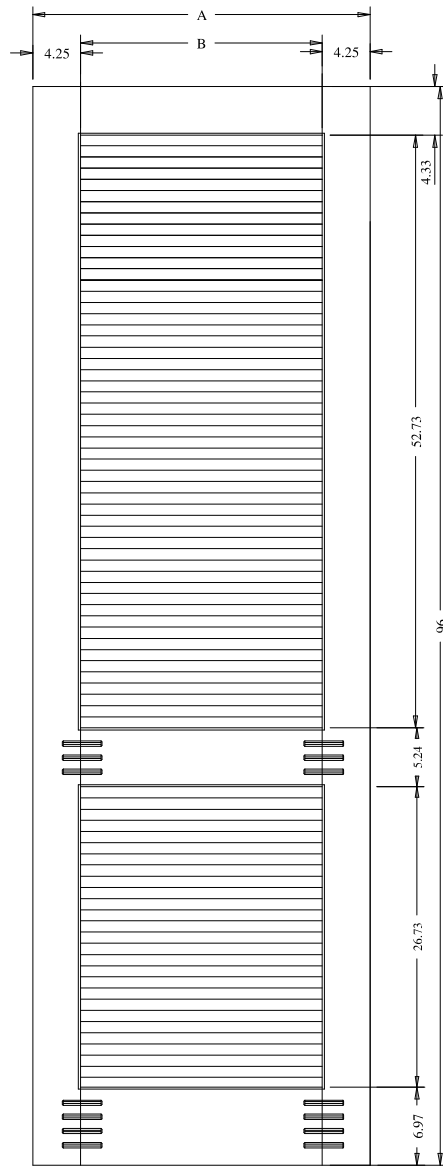

A	B	Slats
18" (457.2)	9.49	12.44
20" (508.0)	11.49	12.44
22" (558.8)	13.49	14.44
24" (609.6)	15.49	16.44
26" (660.4)	17.49	18.44
28" (711.2)	19.49	20.44
30" (762.0)	21.49	22.44
32" (812.8)	23.49	24.44
34" (863.6)	25.49	26.44
36" (914.4)	27.49	28.44

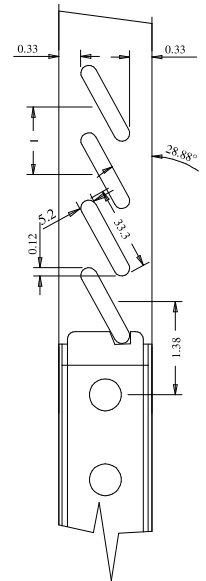
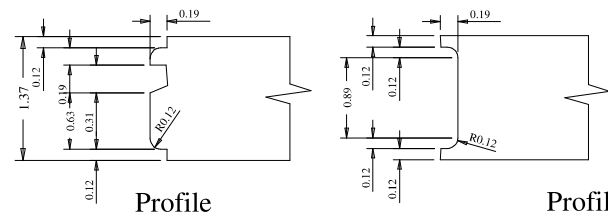
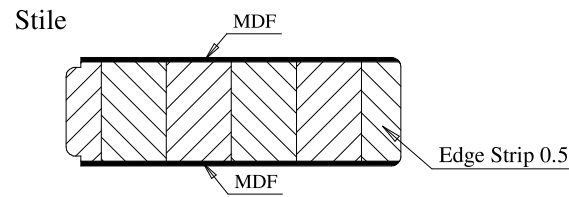

Titulo: RZ#801 - 96" x 18" a 36" x 35mm - PRIMED

SQUARE ONE
BUILDING PRODUCTS

Client	905 - Square One				
Designer	Luiz Antônio	Approval	Charles	Reviewed by	Luiz
Date	23-05-2019	Date	23-05-2019	Review Date	23-05-2019

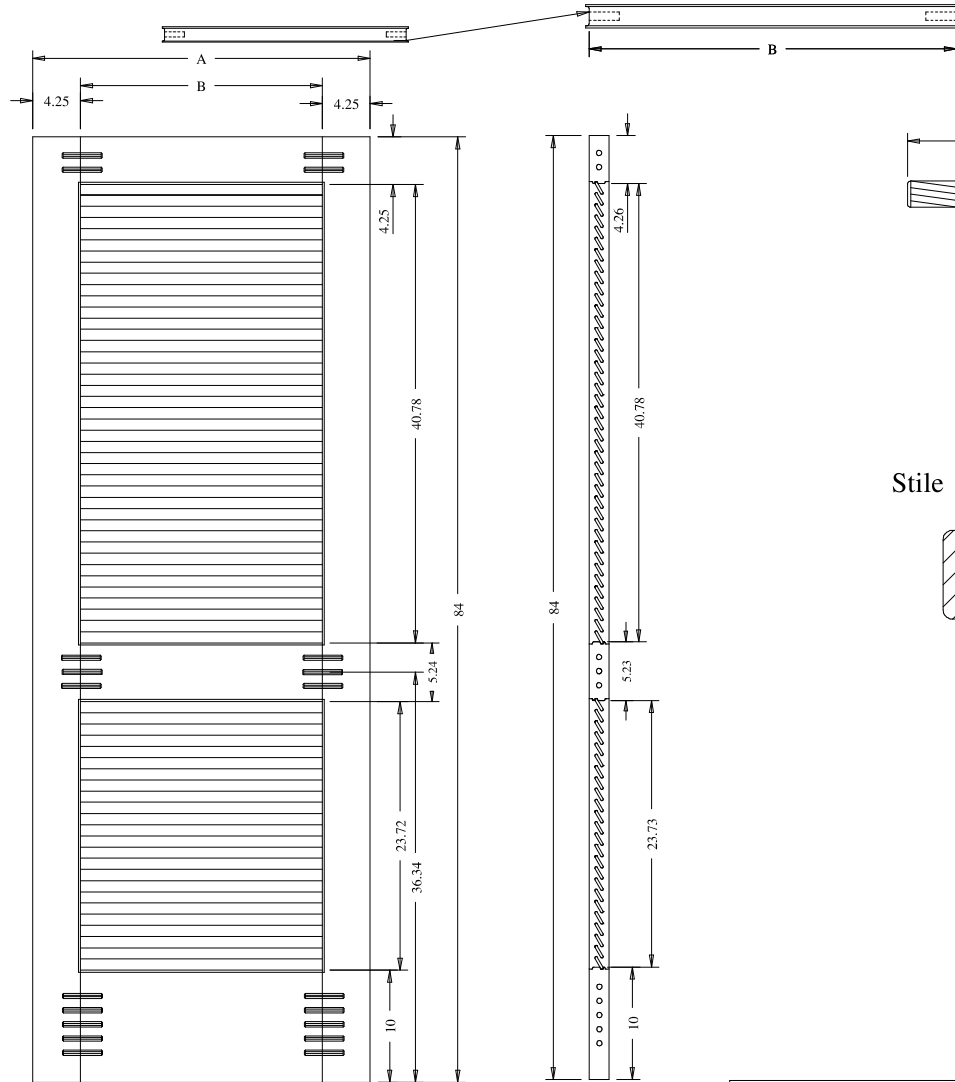

A	B	Slats
18" (457.2)	241.2	265.2
20" (508.0)	11.49	12.44
22" (558.8)	13.49	14.44
24" (609.6)	15.49	16.44
26" (660.4)	17.49	18.44
28" (711.2)	19.49	20.44
30" (762.0)	21.49	22.44
32" (812.8)	23.49	24.44
34" (863.6)	25.49	26.44
36" (914.4)	27.49	28.44

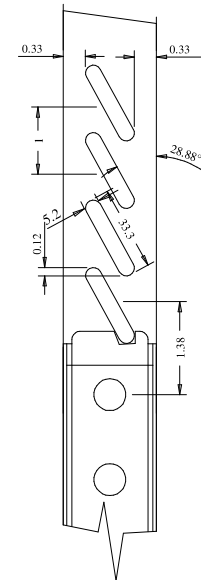
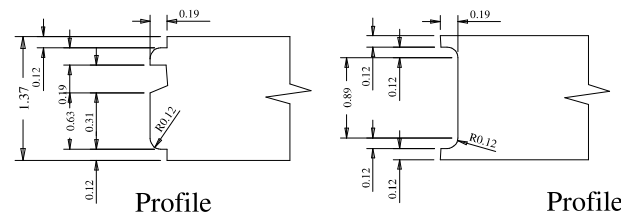
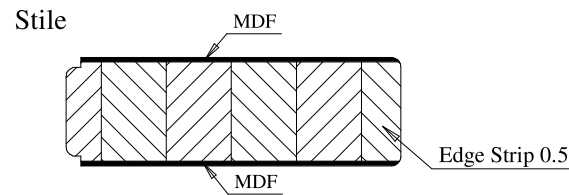
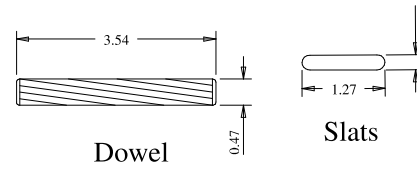

Titulo: RZ#801 - 84" x 18" a 36" x 35mm - PRIMED - PÉ 10"

SQUARE ONE
BUILDING PRODUCTS

Client	963- Square One				
Designer	Luiz Antônio	Approval	Charles	Reviewed by	Luiz Antônio
Date	21-07-2021	Date	21-07-2021	Review Date	21-07-2021

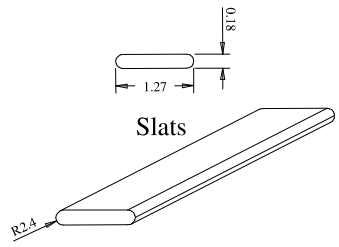
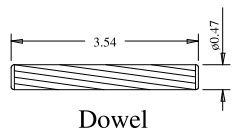
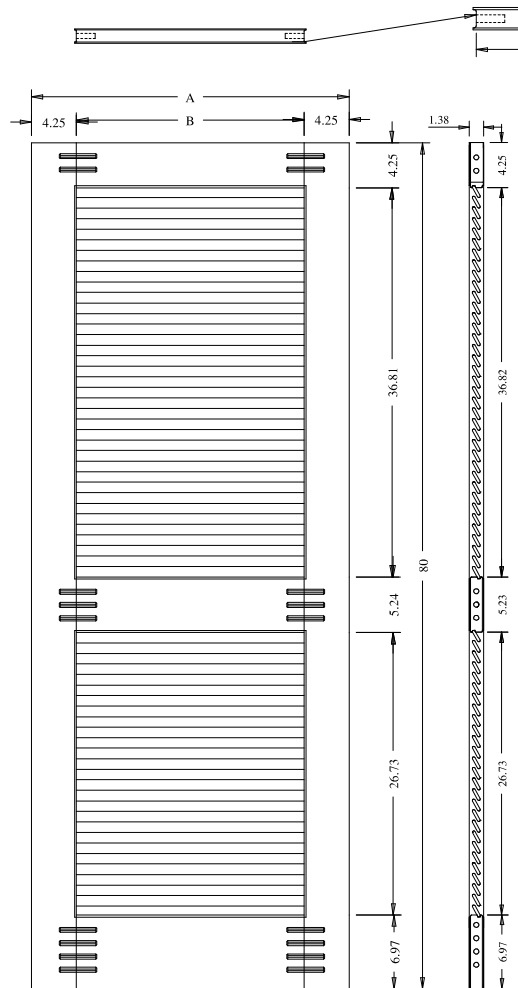

A	B	Slats
18" (457.2)	9.49	12.44
20" (508.0)	11.49	12.44
22" (558.8)	13.49	14.44
24" (609.6)	15.49	16.44
26" (660.4)	17.49	18.44
28" (711.2)	19.49	20.44
30" (762.0)	21.49	22.44
32" (812.8)	23.49	24.44
34" (863.6)	25.49	26.44
36" (914.4)	27.49	28.44

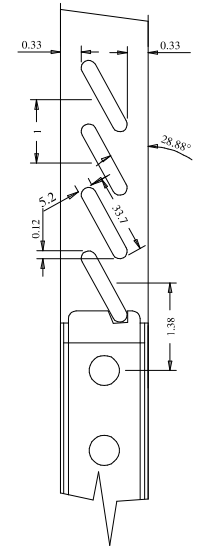
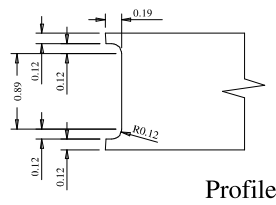
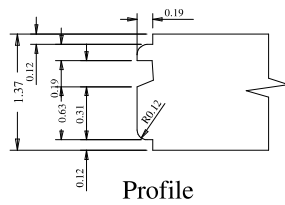
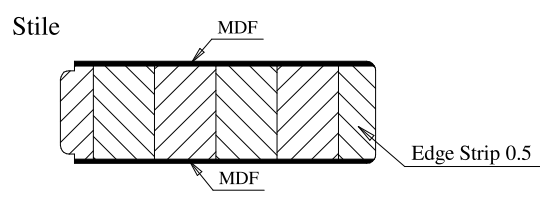

Titulo: RZ#801 - 80" x 18" a 36" x 35mm - Primed						
	Client	963- Square One				
	Designer	Luiz Antônio Cirico	Approval	Charles Agostini	Reviewed by	Luiz
	Date	17/04/2017	Date	17/04/2017	Review Date	17-05-2018

